

# REGO

## 500A Combiner Box

ROA500CB-98

VERSION A0

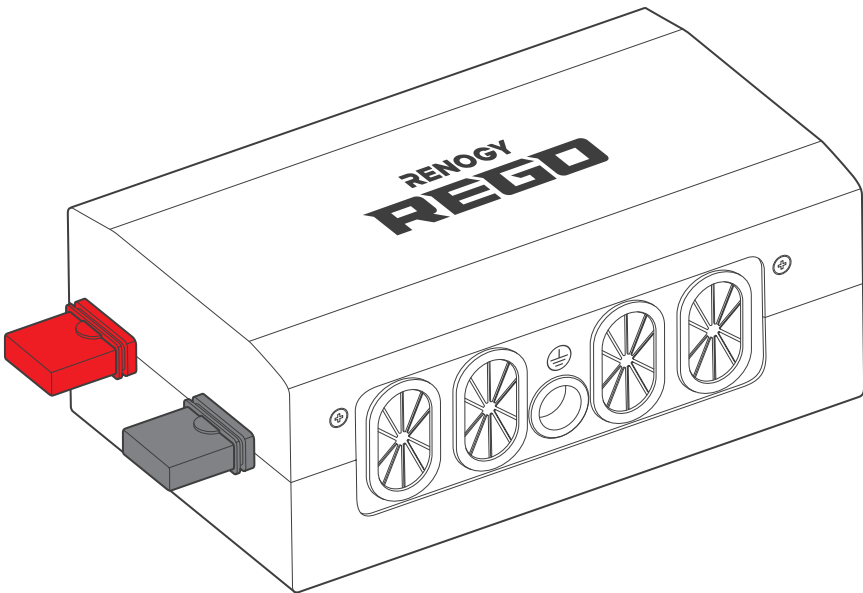

USER MANUAL

## Before Getting Started

The user manual provides important operation and maintenance instructions for REGO 500A Combiner Box (hereinafter referred to as combiner box).

Read the user manual carefully before operation and save it for future reference. Failure to observe the instructions or precautions in the user manual can result in electrical shock, serious injury, or death, or can damage the combiner box, potentially rendering it inoperable.

- Renogy ensures the accuracy, sufficiency, and the applicability of information in the user manual at the time of printing due to continual product improvements that may occur.
- Renogy assumes no responsibility or liability for personal and property losses, whether directly and indirectly, caused by the user's failure to install and use the product in compliance with the user manual.
- Renogy is not responsible or liable for any failure, damage, or injury resulting from repair attempts by unqualified personnel, improper installation, or inappropriate operation.
- The illustrations in the user manual are for demonstration purposes only. Details may appear slightly different depending on product revision and market region.
- Renogy reserves the right to change the information in the user manual without notice. For the latest user manual, visit [renogy.com](https://www.renogy.com).

## Disclaimer

REGO 500A Combiner Box User Manual © 2023 Renogy. All rights reserved.

RENOGY and **RENOGY** are registered trademarks of Renogy.

- All information in the user manual is subject to copyright and other intellectual property rights of Renogy and its licensors. The user manual may not be modified, reproduced, or copied, in whole or in part, without the prior written permissions of Renogy and its licensors.
- The registered trademarks in the user manual are the property of Renogy. The unauthorized use of the trademarks is strictly prohibited.

## Online Manual

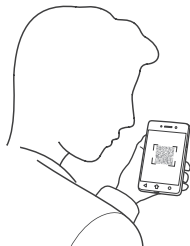

User Manual



# Table of Contents

<b>Symbols Used</b> .....	<b>1</b>
<b>Introduction</b> .....	<b>1</b>
<b>Key Features</b> .....	<b>1</b>
<b>SKU</b> .....	<b>1</b>
<b>What's In the Box?</b> .....	<b>2</b>
<b>Required Tools &amp; Accessories</b> .....	<b>2</b>
<b>Get to Know REGO 500A Combiner Box</b> .....	<b>3</b>
<b>Wiring Diagram</b> .....	<b>4</b>
Use MRBF Fuse.....	4
Use ANL Fuse.....	5
<b>Dimensions</b> .....	<b>5</b>
<b>How to Size Cables?</b> .....	<b>6</b>
<b>How to Install the 3/8 in Lugs (M10 Ring Terminals)?</b> .....	<b>6</b>
<b>How to Connect Energy Devices to the Busbars Safely?</b> .....	<b>7</b>
<b>Step 1. Plan a Mounting Site</b> .....	<b>8</b>
<b>Step 2. Wear Insulating Gloves</b> .....	<b>8</b>
<b>Step 3. Remove the Cover</b> .....	<b>8</b>
<b>Step 4. Mount the Combiner Box</b> .....	<b>9</b>
<b>Step 5. Ground the Combiner Box</b> .....	<b>9</b>
<b>Step 6. Connect Energy Devices to the Combiner Box</b> .....	<b>10</b>
Use MRBF Fuse.....	10
Use ANL Fuse.....	12
<b>Step 7. Install the Cover</b> .....	<b>13</b>
<b>Interconnecting Combiner Boxes</b> .....	<b>13</b>
<b>Specifications</b> .....	<b>15</b>
<b>Maintenance</b> .....	<b>16</b>
<b>Important Safety Instructions</b> .....	<b>17</b>
General .....	17
Combiner Box Safety.....	17
<b>Renogy Support</b> .....	<b>18</b>

## Symbols Used

The following symbols are used throughout the user manual to highlight important information.



**WARNING:** Indicates a potentially dangerous condition which could result in injury or death.



**CAUTION:** Indicates a critical procedure for safe and proper installation and operation.



**NOTE:** Indicates an important step or tip for optimal performance.

## Introduction

The REGO 500A Combiner Box is equipped with two busbars (a negative and a positive) that offer four connections for batteries, loads, or battery chargers, along with a ground connection. It also allows for easy expansion of the system by connecting the box to other combiner boxes through the extend terminals.

This combiner box is compatible with general batteries (12V, 24V, 36V, and 48V), inverters, charge controllers, and battery chargers.

## Key Features

- **Safety and Stability**

The combiner box is equipped with two busbars and supports the installation of fuses, especially Marine Rated Battery (MRBF) fuses, to ensure electrical safety. This also simplifies installation and maintenance with quicker installation and less effort.

- **Compact and Lightweight Design**

The combiner box is compact and lightweight, making it easy to install in any location, while also providing sufficient internal space to accommodate thick wires and larger terminals.

- **Sturdy Outer Casing**

The combiner box protects the system connections with a sturdy outer casing, which remains intact even when subjected to wire bending or twisting.

- **Long-Time Stable Running**

The high-quality tin-plated copper busbars inside ensure the system operates reliably for extended periods.

## SKU

REGO 500A Combiner Box	ROA500CB-98
------------------------	-------------

## What's In the Box?

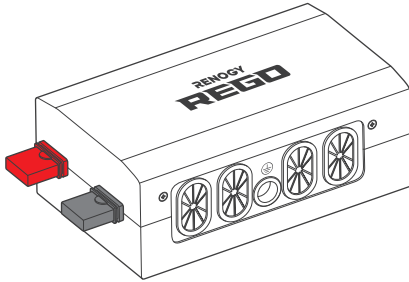

REGO 500A Combiner Box x 1



User Manual x 1

- i** Make sure the combiner box is free of any signs of damage.

## Required Tools & Accessories

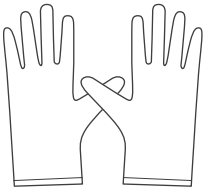

Insulating Gloves



Phillips  
Screwdriver (#2)

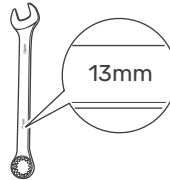

Wrench  
(17/32 in)

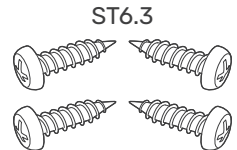

Self-tapping  
Screws x 4



Wire Stripper

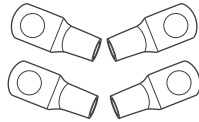

3/8 in Lugs  
(M10 Ring Terminals)

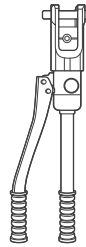

Manual  
Hydraulic Pliers

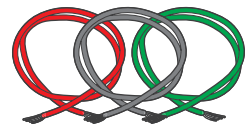

Bare Wires

- i** Prior to installing and configuring the combiner box, prepare the recommended tools, components, and accessories.
- i** For how to size bare wires, refer to "[How to Size Cables?](#)" in this manual.
- i** Choose proper mounting screws specific to your installation site. This manual takes self-tapping screws for wooden walls as an example.

# Get to Know REGO 500A Combiner Box

## Exterior

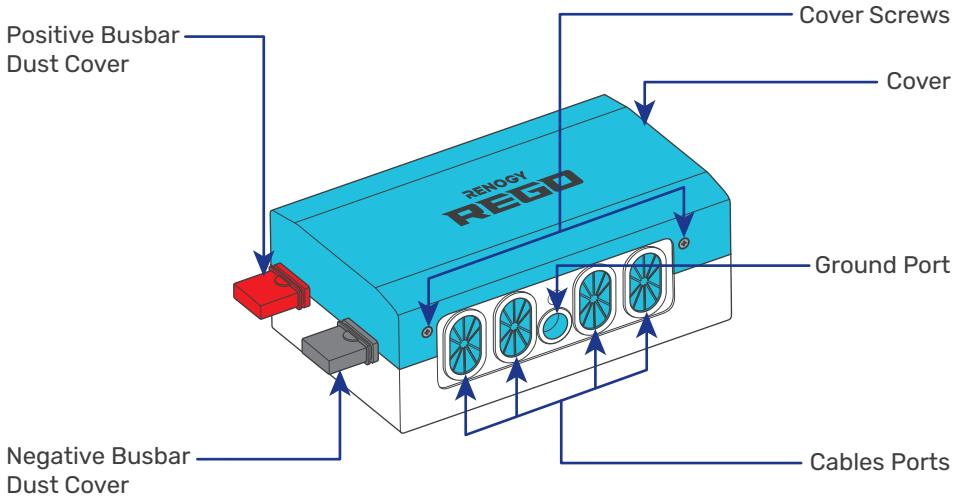

## Interior (with the cover removed)

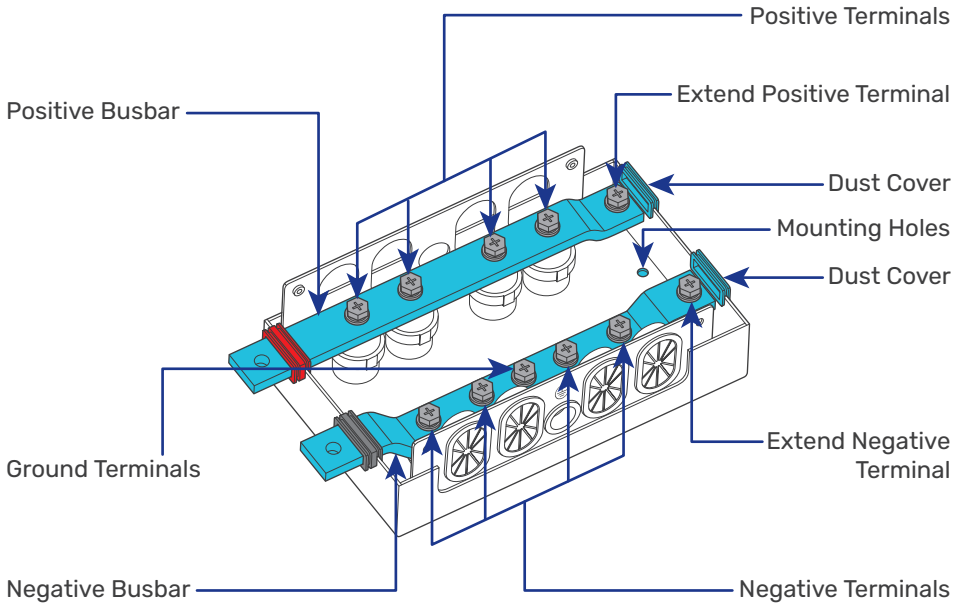

**i** Each busbar terminal is equipped with a terminal bolt, a spring washer, and a flat washer.

## Wiring Diagram

**⚠** The continuous current flowing through the combiner box shall not exceed 500A. The voltage is within the range of 9V to 60V.

**i** The wiring diagram only shows the key components in a typical DC-coupled residential energy storage system for the illustrative purpose. The wiring might be different depending on the system configuration. Additional safety devices, including disconnect switches, emergency stops, and rapid shutdown devices, might be required. Wire the system in accordance with the regulations at the installation site.

### Use MRBF Fuse

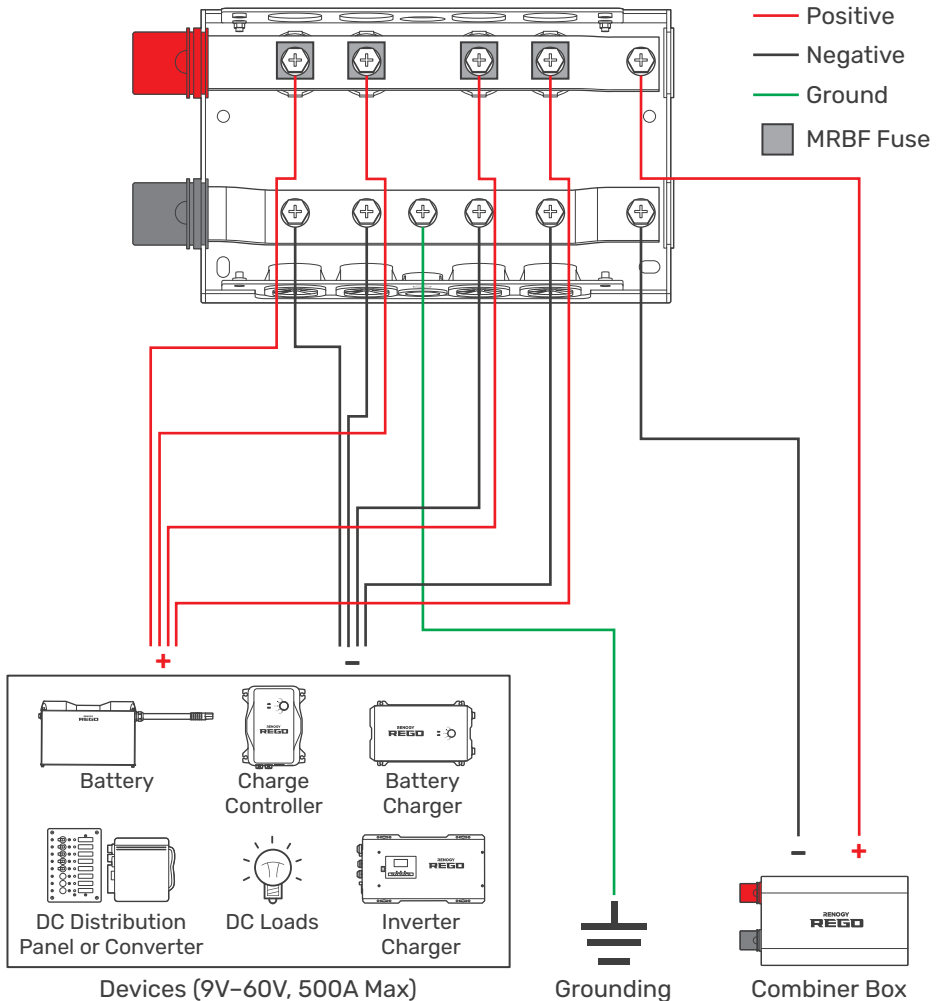

## Use ANL Fuse

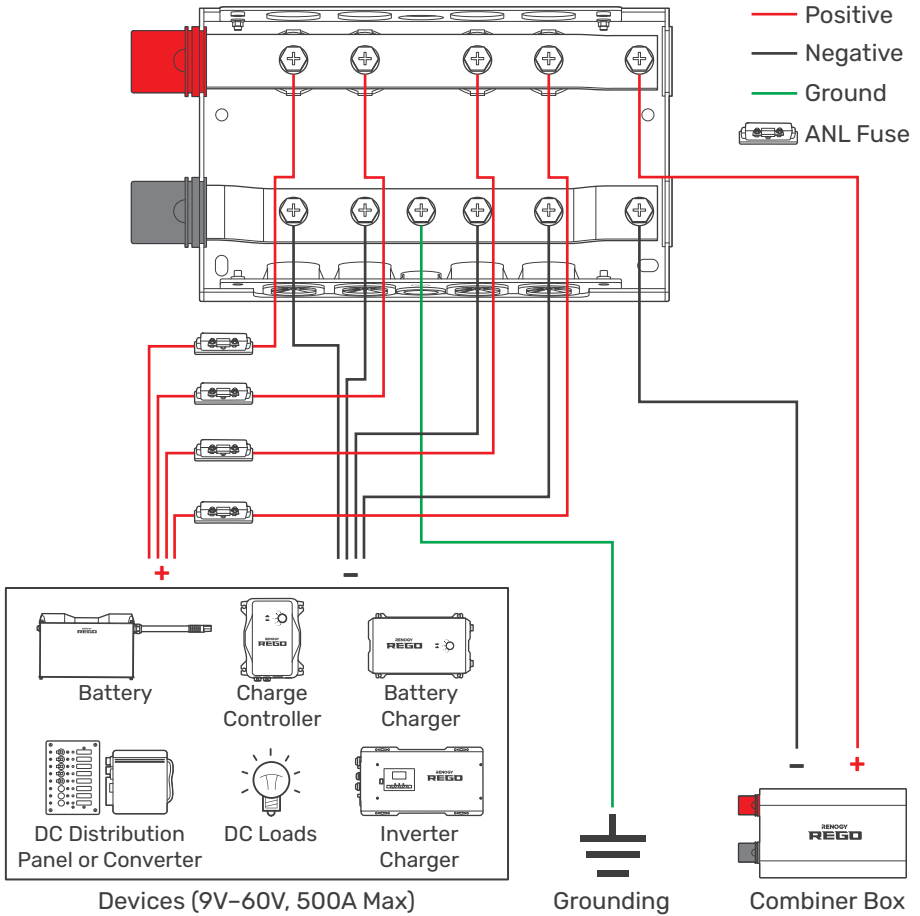

## Dimensions

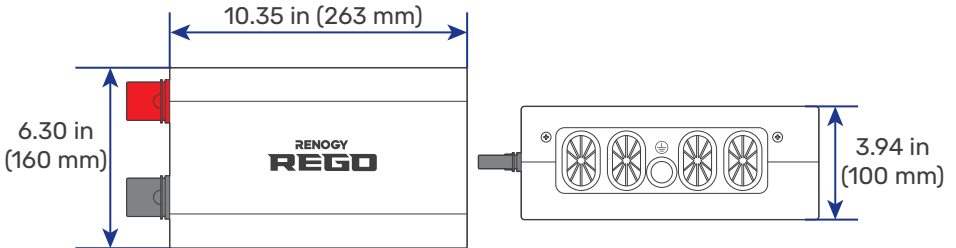

**i** Dimension tolerance:  $\pm 0.2$  in (0.5 mm)



## How to Size Cables?

Size wires specific to the operating current of relevant devices. Refer to the table below for copper cable ampacities with different gauge sizes.

Cable Gauge Size	Ampacity	Cable Gauge Size	Ampacity
14 AWG (2.08 mm <sup>2</sup> )	35A	2 AWG (33.6 mm <sup>2</sup> )	190A
12 AWG (3.31 mm <sup>2</sup> )	40A	1 AWG (42.4 mm <sup>2</sup> )	220A
10 AWG (5.25 mm <sup>2</sup> )	55A	1/0 AWG (53.5 mm <sup>2</sup> )	260A
8 AWG (8.36 mm <sup>2</sup> )	80A	2/0 AWG (67.4 mm <sup>2</sup> )	300A
6 AWG (13.3 mm <sup>2</sup> )	105A	4/0 AWG (107 mm <sup>2</sup> )	405A
4 AWG (21.1 mm <sup>2</sup> )	140A		

**i** The above values are from the NEC Table 310.15(B)16 for copper cables rated at 167°F (75°C), operating at an ambient temperature of no more than 86°F (30°C). Cables longer than 6 feet (1829 mm) may require thicker gauge wires to prevent excessive voltage drop in undersized wiring.

## How to Install the 3/8 in Lugs (M10 Ring Terminals)?

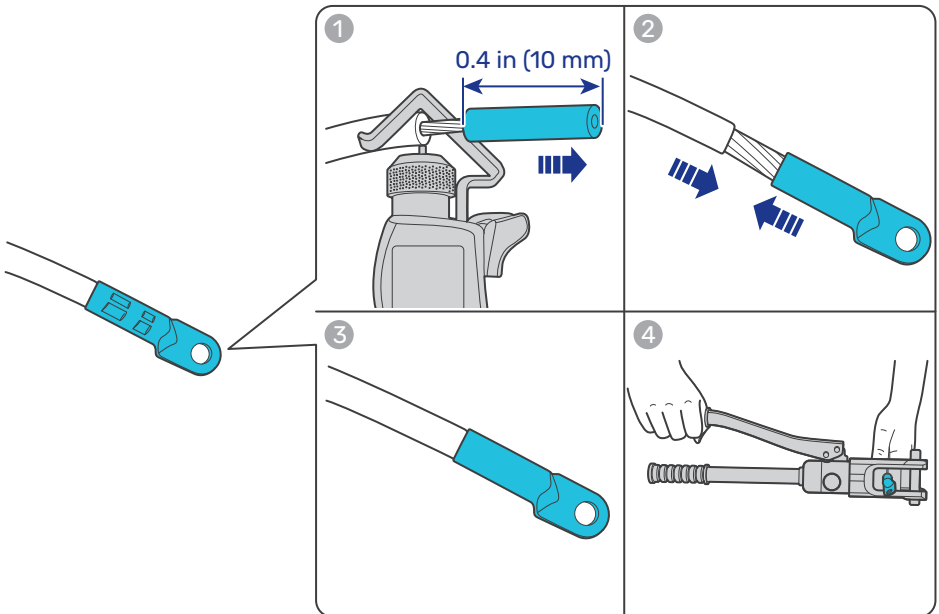

## How to Connect Energy Devices to the Busbars Safely?

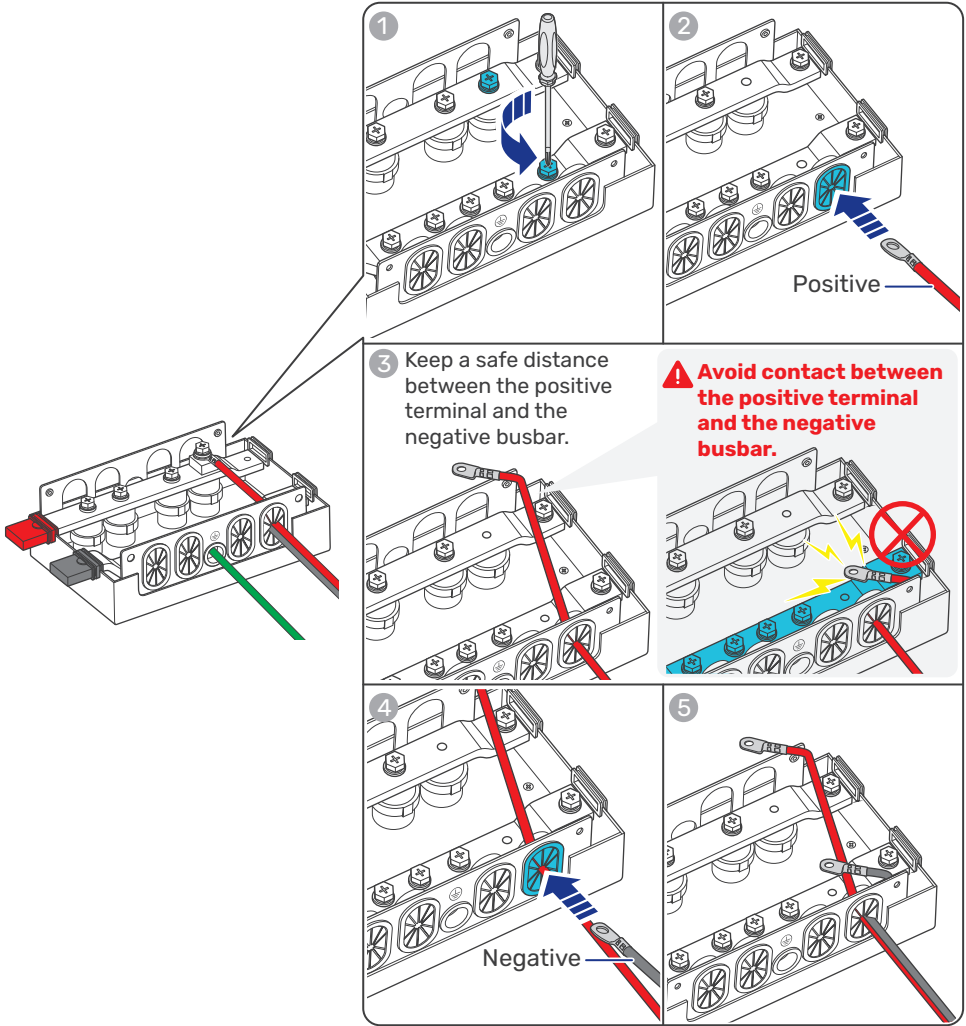

⚠️ Ensure that the positive busbar terminal does not come into contact with the negative busbar terminal. Short circuits can damage connected batteries and devices.

## Step 1. Plan a Mounting Site

Install the combiner box in a clean, cool, and dry place. Keep water, oil, and dirt away from the combiner box, and protect it from direct sunlight.

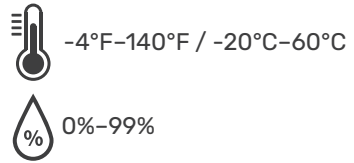
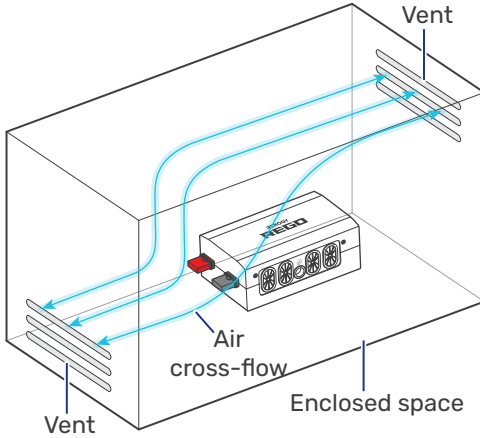

**i** The combiner box can be mounted either on a floor or on a wall.

## Step 2. Wear Insulating Gloves

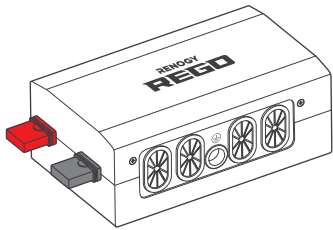

Insulating  
Gloves

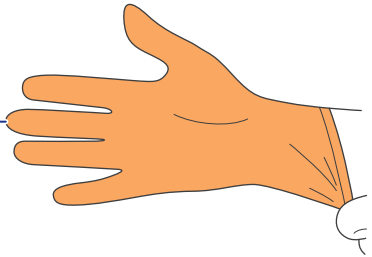

## Step 3. Remove the Cover

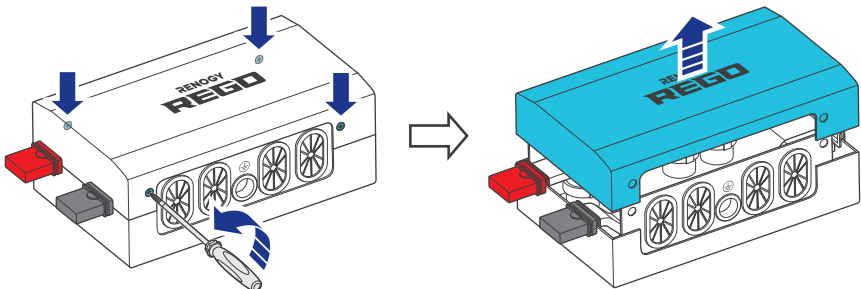

## Step 4. Mount the Combiner Box

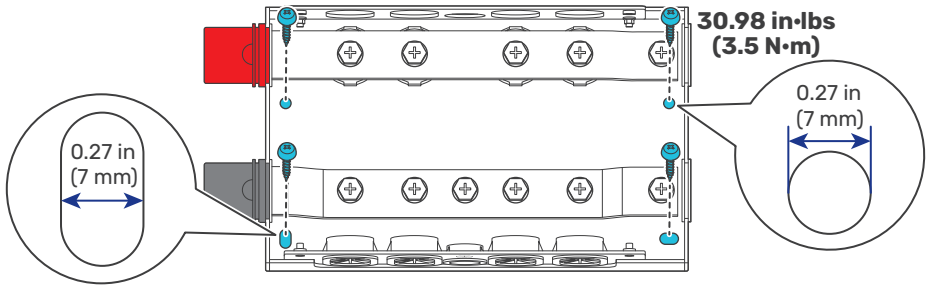



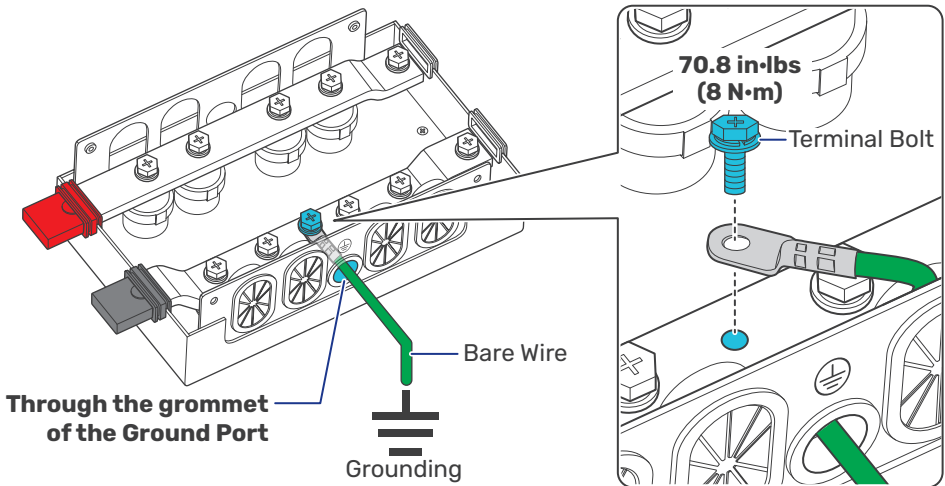

- i** Make sure that the combiner box is installed firmly to prevent it from falling off.
- i** Inspect the combiner box for any visible damage including cracks, dents, deformation, and other visible abnormalities. All terminal contacts shall be clean, free of dirt and corrosion, and dry.

## Step 5. Ground the Combiner Box



## Step 6. Connect Energy Devices to the Combiner Box

Install wires on energy devices (charge controller, battery, inverter, and more) prior to connecting them to the combiner box. For details on how to install wires on the devices, see the user manual of the specific device. Always install the negative terminals before positive ones. The following figure takes connecting a REGO 12V 60A MPPT Solar Charge Controller to the combiner box as an example.

-  Ensure the cable lug and the busbar terminal are in contact, and place the washers on top of the lug. Do not place the washers between the busbar terminal and the cable lug to avoid high resistance and excessive heating.
-  Ensure that the positive busbar terminal does not come into contact with the negative busbar terminal. Short circuits can damage connected batteries and devices.
-  Check the polarity before connecting the cables. Reverse polarity can damage connected batteries and devices.
-  To ensure safe and reliable operation of the system, please follow the torque specifications of relevant devices recommended by the manufacturer securing cable connections. Over-tightening can cause terminal breakage, while loose connections can lead to terminal meltdown or fire hazards.

### Use MRBF Fuse

#### Recommended Components

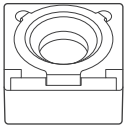

MRBF Fuse

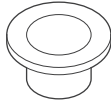

Insulating Sleeve

M8 x 35 mm

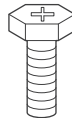

Long Terminal Bolt



Spring Washer

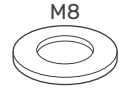

Flat Washer

-  Choose proper MRBF fuses (not included) to meet specifications of the relevant devices. For details, see the user manuals of the relevant devices.

**STEP-1 Install the negative**

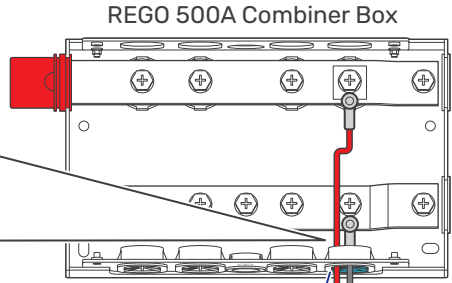
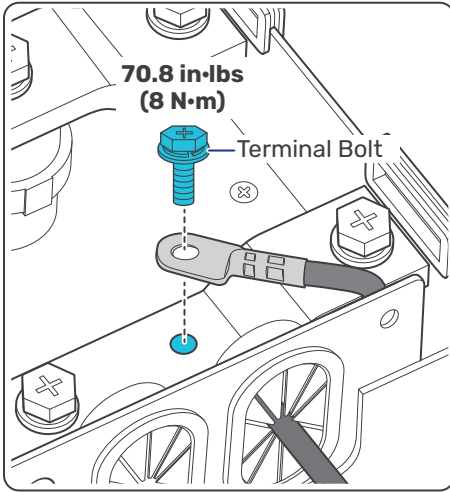

Through the grommet  
of the Cables Port

Bare Wires

**STEP-2 Install the MRBF fuse and positive**

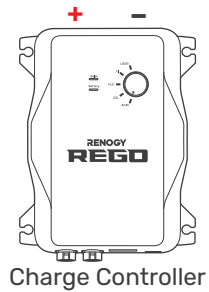
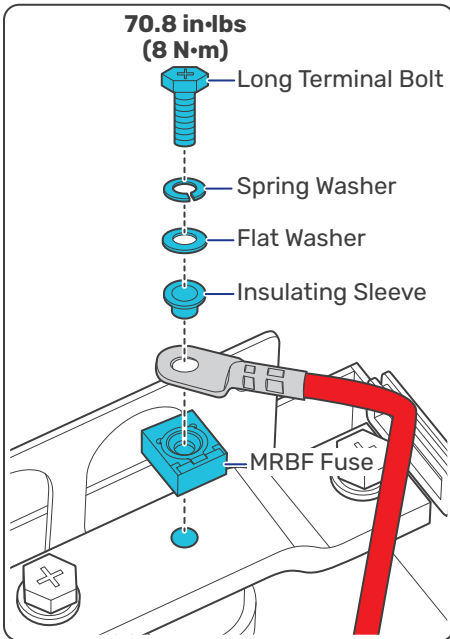

## Use ANL Fuse

### Recommended Components

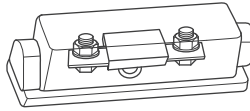

ANL Fuse

**i** Choose proper ANL fuses (not included) to meet specifications of the relevant devices. For details, see the user manuals of the relevant devices.

#### STEP-1 Install the negative

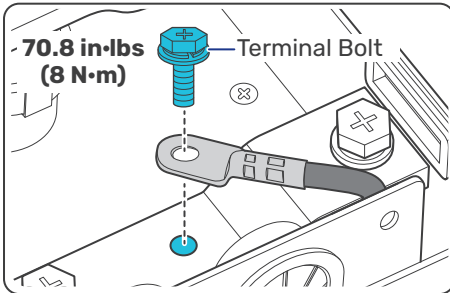

#### STEP-2 Install an ANL fuse

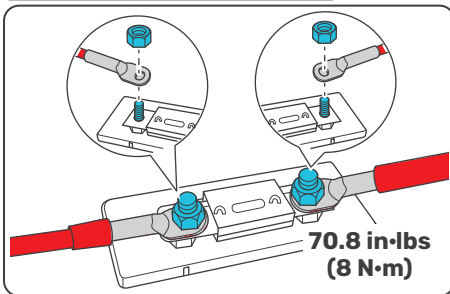

#### STEP-3 Install the positive

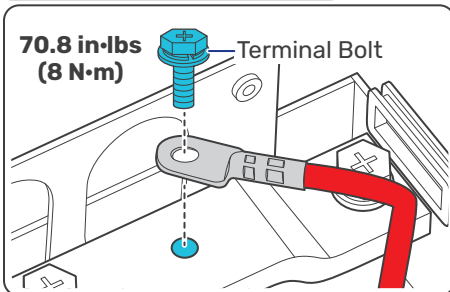

#### REGO 500A Combiner Box

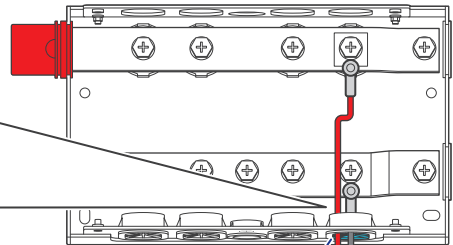

Through the grommet  
of the Cables Port

Bare Wires

ANL Fuse

Bare Wires

+

-

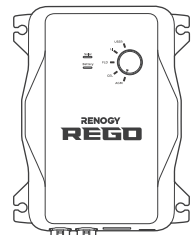

Charge Controller

## Step 7. Install the Cover

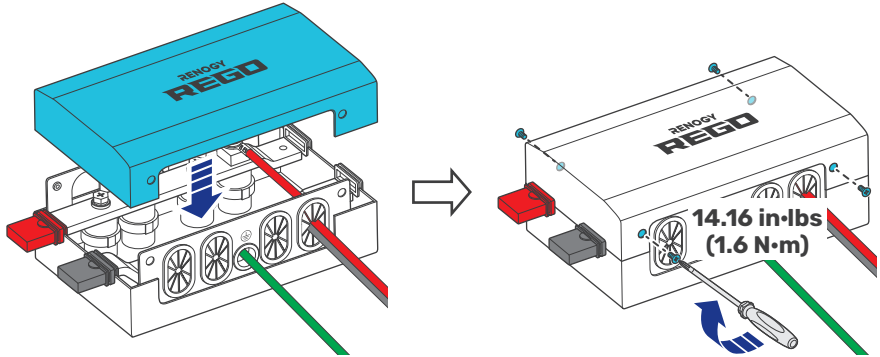

## Interconnecting Combiner Boxes

**Step 1:** Remove the dust covers and extend positive/negative terminals from the first combiner box. Similarly, remove the dust covers from the positive and negative busbars from the second combiner box.

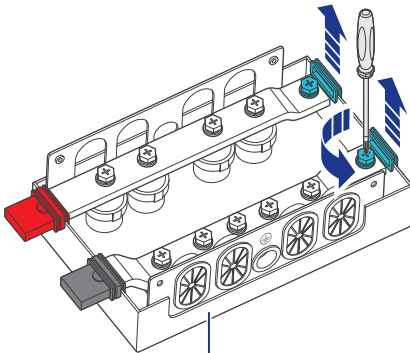

First Combiner Box

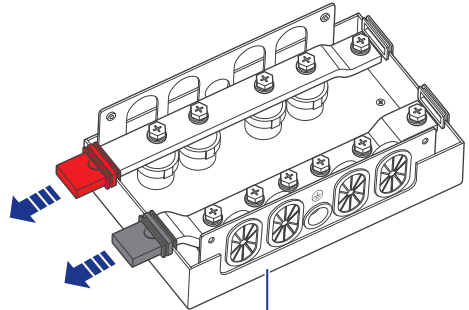

Second Combiner Box



**Step 2:** Align the busbar ports.

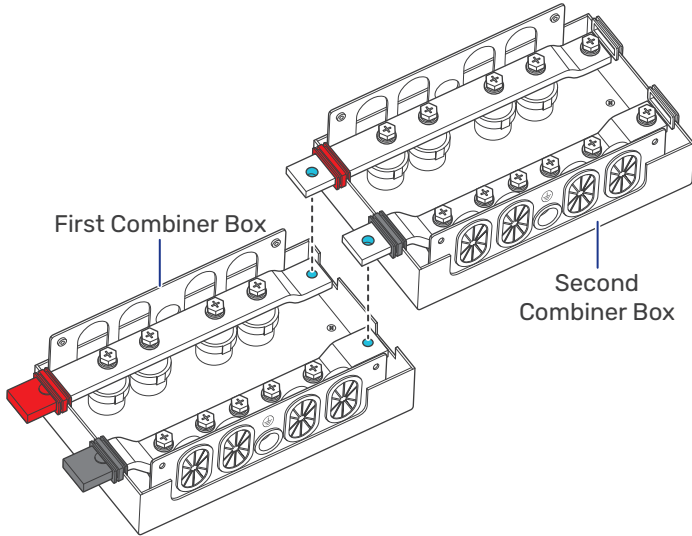

**Step 3:** Install the terminal bolts, spring washers, and flat washers on the busbar ports.

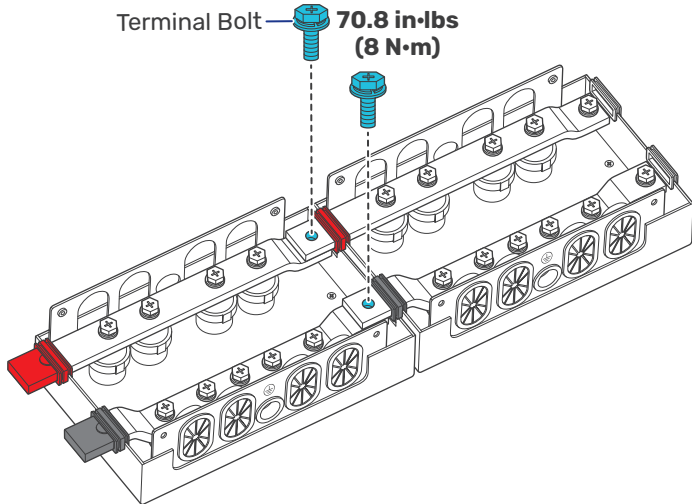

## Specifications

<b>Voltage Range</b>	9V to 60V DC
<b>Rated Current</b>	500A
<b>Connector</b>	M8 Busbar
<b>Enclosure Material</b>	Sheet Metal
<b>Enclosure Dimensions</b>	10.35 x 6.30 x 3.94 in 263 x 160 x 100 mm
<b>Weight</b>	5.73 lbs. / 2.6 kg
<b>Busbar Material</b>	Tinned Copper
<b>Busbar Dimensions</b>	0.31 x 1.18 in 8 x 30 mm
<b>Recommended Terminal Torque</b>	70.8 in·lbs / 8 N·m
<b>Operating Temperature Range</b>	-4°F to 140°F / -20°C to 60°C
<b>Storage Temperature Range</b>	-40°F to 176°F / -40°C to 80°C
<b>Humidity</b>	0-99% RH (non-condensing)
<b>Protection Class</b>	IP22

## Maintenance

### Inspection

Please perform regular inspections following the steps below:

- Examine the external appearance of the combiner box. The casing and terminals of the combiner box shall be clean, dry, and free of corrosion.
- Check the continuity of the fuses. Replace any blown fuses.
- Check the cables and connections. Replace any damaged cables and tighten any loose connections.

 In certain application scenarios, corrosion may occur around the terminals. Corrosion can cause increased resistance and poor contact. It is recommended to regularly apply insulation grease to each terminal. Insulation grease can form a moisture-resistant seal and protect the terminals from corrosion.

### Cleaning

Please clean the combiner box at regular intervals following the steps below.

- Disconnect the devices and batteries or battery combiner box from the combiner box.
- Clean the casing and terminals. The household cleaner can be used if the combiner box is extremely dirty.
- Use a clean cloth to dry the combiner box. Ensure that the area surrounding the combiner box remains clean and dry.
- Reconnect the necessary devices to the combiner box.

## Important Safety Instructions

### General

- Wear proper protective equipment and use insulated tools during installation and operation. Do not wear jewelry or other metal objects when working on or around the combiner box.
- Keep the combiner box out of the reach of children.
- Do not dispose of the combiner box as household waste. Comply with local, state, and federal laws and regulations and use recycling channels as required.
- In case of fire, put out the fire with a FM-200 or CO<sub>2</sub> fire extinguisher.
- Do not expose the combiner box to flammable or harsh chemicals or vapors.
- Clean the combiner box regularly.
- It is recommended that all cables should not exceed 32.8 ft (10 m) because excessively long cables result in a voltage drop.
- The cable specifications listed in the user manual account for critical, less than 3% voltage drop and may not account for all configurations.
- Do not expose the combiner box to strong electrostatic fields, strong magnetic fields, or radiation.

### Combiner Box Safety

- Please keep the combiner box away from water, heat sources, sparks, and hazardous chemicals.
- Do not puncture, drop, crush, burn, penetrate, shake, strike, or step on the combiner box.
- Do not repair, tamper with, or modify the combiner box.
- Do not touch any terminals.
- Please make sure all devices have been disconnected before working on the combiner box.
- Do not place tools on top of the combiner box.
- Do not insert foreign objects into the positive and negative terminals of the combiner box.
- Ensure the connected devices are off before connecting them to the combiner box.

## Renogy Support

**To discuss inaccuracies or omissions in this quick guide or user manual,** visit or contact us at:

 | [renogy.com/support/downloads](https://renogy.com/support/downloads)



→ [contentservice@renogy.com](mailto:contentservice@renogy.com)

**To explore more possibilities of solar systems,** visit Renogy Learning Center at:

 | [renogy.com/learning-center](https://renogy.com/learning-center)



**For technical questions about your product in the U.S.,** contact the Renogy technical support team through:

 | [renogy.com/contact-us](https://renogy.com/contact-us)



1(909)2877111

**For technical support outside the U.S.,** visit the local website below:

**Canada** |  | [ca.renogy.com](https://ca.renogy.com)

**China** |  | [www.renogy.cn](https://www.renogy.cn)

**Australia** |  | [au.renogy.com](https://au.renogy.com)

**Japan** |  | [renogy.jp](https://renogy.jp)

**South Korea** |  | [kr.renogy.com](https://kr.renogy.com)

**Germany** |  | [de.renogy.com](https://de.renogy.com)

**United Kingdom** |  | [uk.renogy.com](https://uk.renogy.com)

**Other Europe** |  | [eu.renogy.com](https://eu.renogy.com)



## Renogy Empowered

Renogy aims to empower people around the world through education and distribution of DIY-friendly renewable energy solutions.

We intend to be a driving force for sustainable living and energy independence.

In support of this effort, our range of solar products makes it possible for you to minimize your carbon footprint by reducing the need for grid power.



## Live Sustainably with Renogy

Did you know? In a given month, a 1 kW solar energy system will...



Save 170 pounds of coal from being burned



Save 300 pounds of CO<sub>2</sub> from being released into the atmosphere



Save 105 gallons of water from being consumed



## Renogy Power PLUS

Renogy Power Plus allows you to stay in the loop with upcoming solar energy innovations, share your experiences with your solar energy journey, and connect with like-minded people who are changing the world in the Renogy Power Plus community.



@Renogy Solar



@renogyofficial



@Renogy

Renogy reserves the right to change the contents of this manual without notice.

